



مصنع جاما للمعدات المعدنية GAMMA FACTORY FOR METAL IND.

GAMMA CABINETS COMPLYING WITH INTERNATIONAL STANDARD:

- ISO 9001 :2015
- ISO 14001:2015
- EIA/ECA- 310 E & EIA-310 D
- IEC 297-1 19" MOUNTING
- IEC 297-2 Overall cabinet dimensions
- IP20 Protected for Indoor Cabinet
- IP65/IP66 Protected for Outdoor Cabinets



Free Standing Racks



Wall Mounted Cabinets



Open Racks



Battery Enclosures



Outdoor Metal Enclosures



MADE IN K.S.A



Datacom/Telecom Racks & Cabinets Catalog
GAMMA Cabinets Fits all 19" equipment by complying with EIA-310-D and ETSI specifications

مصنع جاما للمعدات المعدنية
GAMMA FACTORY FOR METAL IND.



**GAMMA CABINETS MANUFACTURED ACCORDING TO
EIA-310 E , ETSI SPECIFICATIONS**
Gamma Data Cabinets Fit all 19" Equipment's

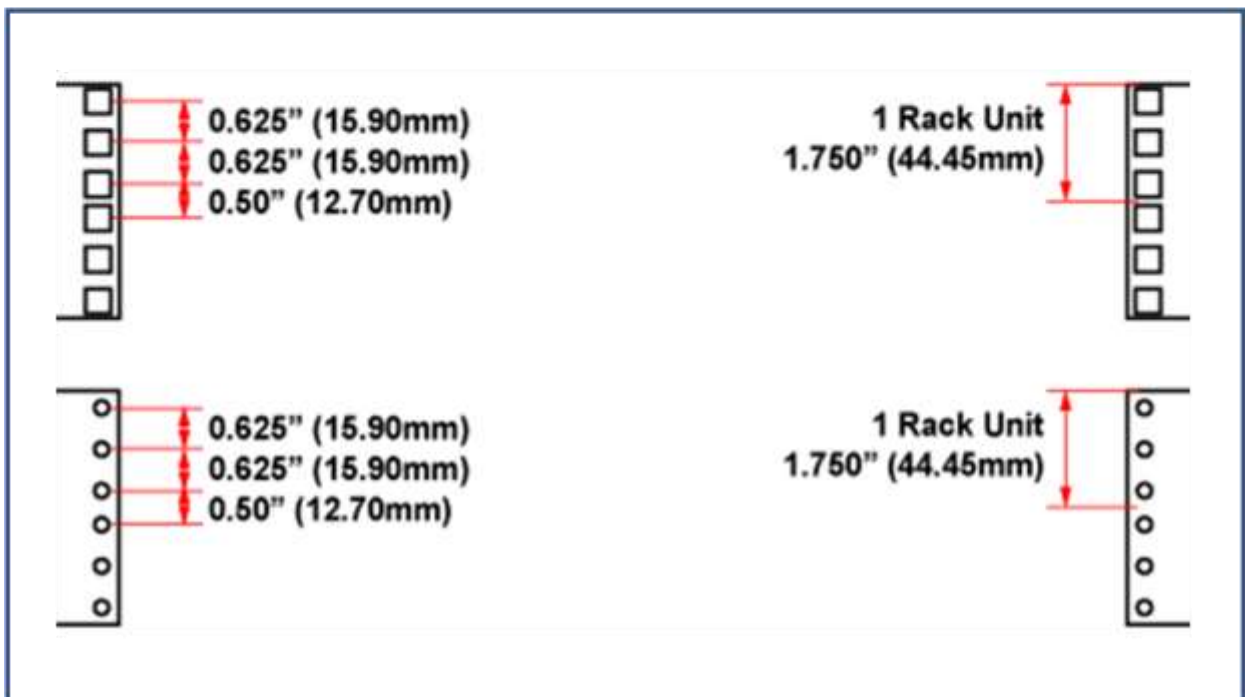
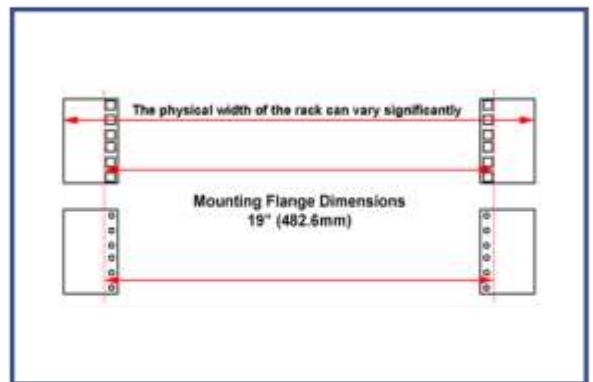
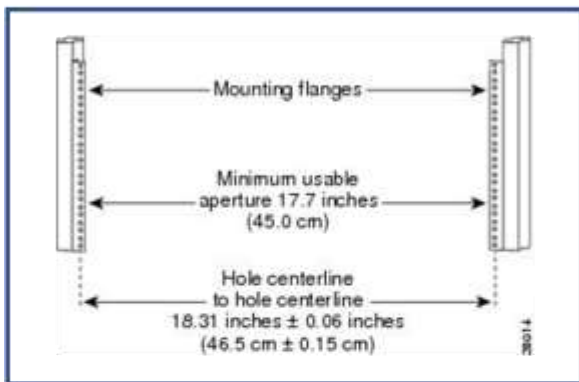



GAMMA NET FREE STAND CABINETS





GAMMA NET FREE STAND RACK CABINETS (36U-42U-47U)

Standard Dimensions :

Height : 36U – 42U-47U

Width : 600 – 800 mm

Depth : 600-800-1000-1200 mm

Standard Colour :

RAL 9005 BLACK

RAL 7035 Light Gray

Other colours available on request



Complying with International Standards:

- ISO 9001 : 2015
- ISO 14001 : 2015
- EIA/ECA- 310 E & EIA-310 D
- IEC 297-1 19" MOUNTING
- IEC 297-2 Overall cabinet dimensions
- IP20 Protected



Features:

- Structure made from steel sheet.
- 6mm Tempered Glass Door with Locking and Swing Handle.
- Steel Sheet Rear Door with Locking.
- 4 pcs 19" Mounted Rails.
- Lift off Side Panels with Quick Release Fastener for easy access.
- Roof Plate for Cable Entry and Ventilation.
- Fan Mounting Plate with two or four fans.
- Base Plinth Component with optional Gland Plates for Cable Entry.
- Fixed or Sliding Shelves (option)
- Four Casters for Transportation and four Adjustable Leveling Feet.
- Static Load Rating 800kg
- Gamma Racks Cabinets are finished in a durable powder coating line.
- Color Gray RAL 7035 or Black 9005
- Gamma Cabinets comply with EIA -310 -D 19" Standard





GAMMA NET FREE STAND RACK CABINETS SIZE 36U – 42U – 47 U

Part Number	Description - Standard Configuration - Colour Black RAL 9005	Width (W) mm	Depth (D) mm	Height (H) mm	Depth Rail to Rail (mm)	Static Load (KG)
GMC-FR-36U-66-2F	Gamma Net Free Stand Cabinet 36U 600x600 with Removable Side Door , Front Glass , Metal Back door , 2 pair of 19" Adjustable Pillars , 2 pair of caster Wheels , 2 Fan	600	600	1720	500	600
GMC-FR-36U-68-4F	Gamma Net Free Stand Cabinet 36U 600x800 with Removable Side Door , Front Glass , Metal Back door , 4 pair of 19" Adjustable Pillars , 2 pair of caster Wheels , 4 Fan	600	800	1720	700	600
GMC-FR-36U-610-4F	Gamma Net Free Stand Cabinet 36U 600x1000 with Removable Side Door , Front Glass , Metal Back door , 2 pair of 19" Adjustable Pillars , 2 pair of caster Wheels , 4 Fan	600	1000	1720	900	600
GMC-FR-42U-66-4F	Gamma Net Free Stand Cabinet 42U 600x600 with Removable Side Door , Front Door Glass , Metal Back door , 2 pair of 19" Adjustable Mounting Pillars , 2 pair of caster Wheels , 4 Fan	600	600	2020	500	800
GMC-FR-42U-68-4F	Gamma Net Free Stand Cabinet 42U 600x800 with Removable Side Door , Front Door Glass , Metal Back door , 2 pair of 19" Adjustable Mounting Pillars , 2 pair of caster Wheels , 4 Fan	600	800	2020	700	800
GMC-FR-42U-610-4F	Gamma Net Free Stand Cabinet 42U 600x1000 with Removable Side Door , Front Door Glass , Metal Back door , 2 pair of 19" Adjustable Pillars , 2 pair of caster Wheels , 4 Fan	600	1000	2020	900	800
GMC-FR-42U-612-4F	Gamma Net Free Stand Cabinet 42U 600x1200 with Removable Side Door , Front Glass , Metal Back door , 2 pair of 19" Adjustable Pillars , 2 pair of caster Wheels , 4 Fan	600	1200	2020	1100	800
GMC-FR-42U-88-4F	Gamma Net Free Stand Cabinet 42U 800x800 with Removable Side Door , Front Door Glass , Metal Back door , 2 pair of 19" Adjustable Mounting Pillars , 2 pair of caster Wheels , 4 Fan	800	800	2020	700	800
GMC-FR-42U-810-4F	Gamma Net Free Stand Cabinet 42U 800x1000 with Removable Side Door , Front Door Glass , Metal Back door , 2 pair of 19" Adjustable Pillars , 2 pair of caster Wheels , 4 Fan	800	1000	2020	900	800
GMC-FR-42U-812-4F	Gamma Net Free Stand Cabinet 42U 800x1200 with Removable Side Door , Front Door Glass , Metal Back door , 2 pair of 19" Adjustable Pillars , 2 pair of caster Wheels , 4 Fan	800	1200	2020	1100	800
GMC-FR-47U-66-4F	Gamma Net Free Stand Cabinet 47U 600x600 with Removable Side Door , Front Door Glass , Metal Back door , 2 pair of 19" Adjustable Mounting Pillars , 2 pair of caster Wheels , 4 Fan	600	600	2220	700	800
GMC-FR-47U-68-4F	Gamma Net Free Stand Cabinet 47U 600x800 with Removable Side Door , Front Door Glass , Metal Back door , 2 pair of 19" Adjustable Mounting Pillars , 2 pair of caster Wheels , 4 Fan	600	800	2220	700	800
GMC-FR-47U-610-4F	Gamma Net Free Stand Cabinet 47U 600x1000 with Removable Side Door , Front Door Glass , Metal Back door , 2 pair of 19" Adjustable Pillars , 2 pair of caster Wheels , 4 Fan	600	1000	2220	900	800
GMC-FR-47U-612-4F	Gamma Net Free Stand Cabinet 47U 600x1200 with Removable Side Door , Front Door Glass , Metal Back door , 2 pair of 19" Adjustable Pillars , 2 pair of caster Wheels , 4 Fan	600	1200	2220	1100	800

OTHER SIZES AVAILABLE ON REQUEST



GAMMA NET FREE STAND RACK CABINETS DRAWING – GLASS DOORS

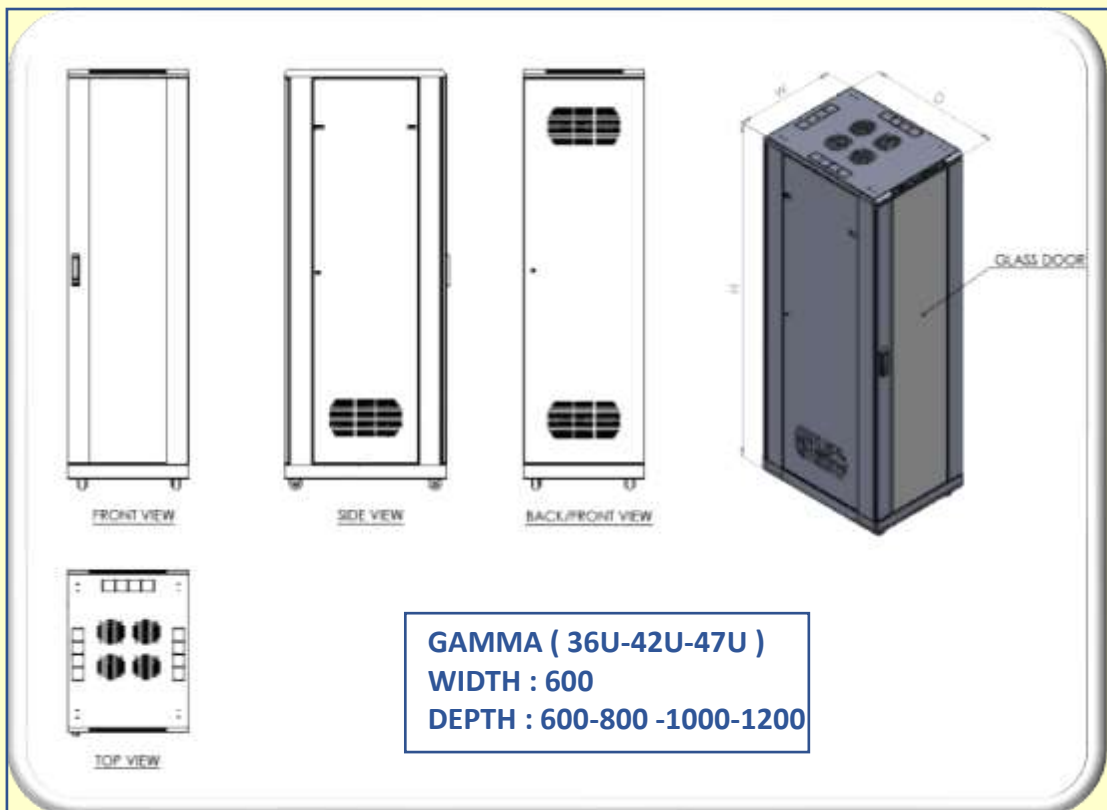
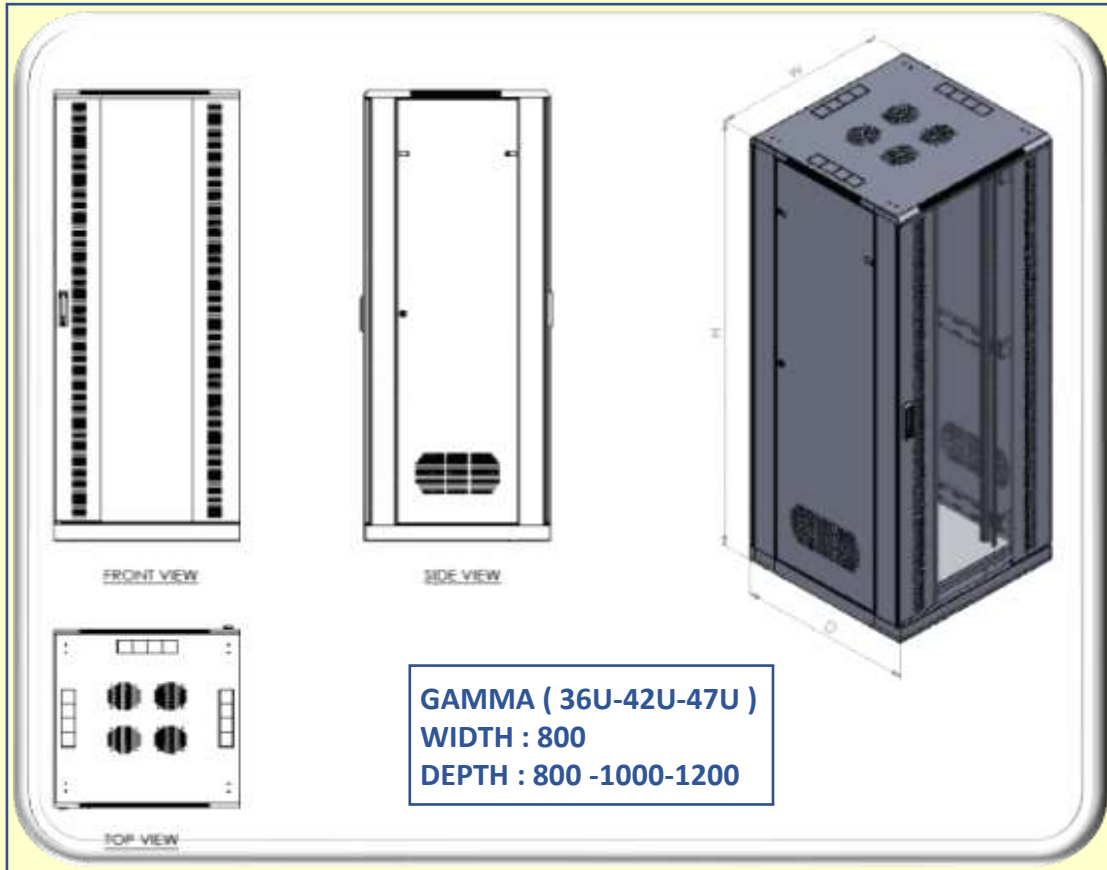



GAMMA NET FREE STAND RACK CABINETS DRAWING – PERFORATED DOORS

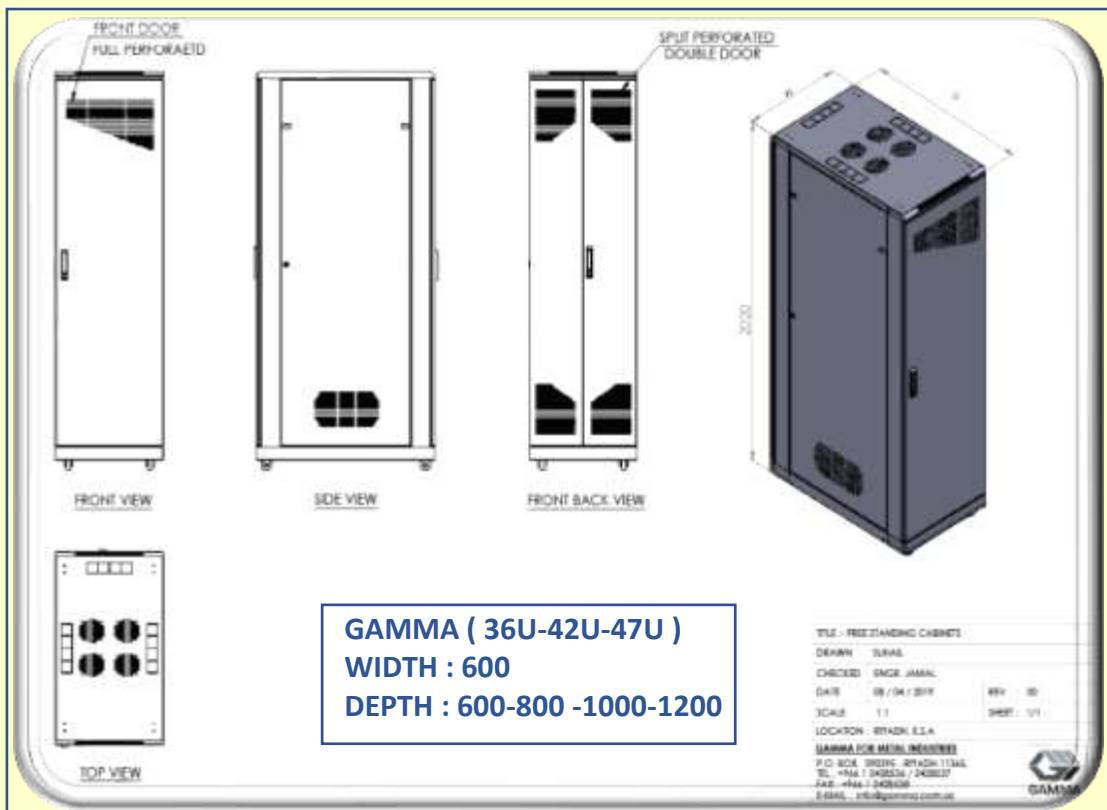
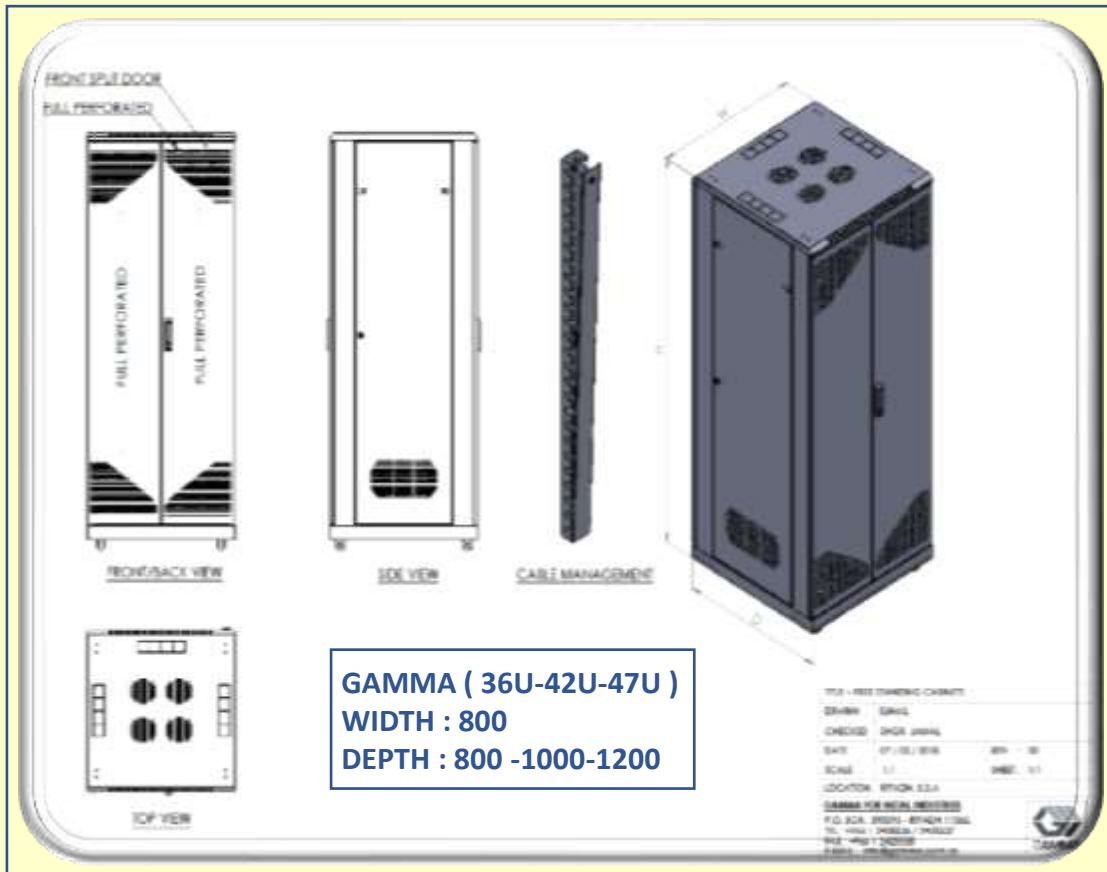



GAMMA NET FREE STAND RACK CABINETS (18U-22U-26U)

Standard Dimensions :

Height : 18U – 22U - 26U

Width : 600 – 800 mm

Depth : 600-800-1000-1200 mm

Standard Colour :

RAL 9005 BLACK

RAL 7035 Light Gray

Other colours available on request



Complying with International Standards:

- ISO 9001 : 2015 • ISO 14001:2015 • EIA/ECA- 310 E & EIA-310 D
- IEC 297-1 19" MOUNTING • IEC 297-2 Overall cabinet dimensions • IP20 Protected



Features :

- Structure Made from Fully Welded Sabcic Steel .
- 6 mm Tempered Front Glass Door with Key Lock
- Steel Rear door with Key lock
- 2 Pair of 19" Mounting Rails depth Adjustable
- Fan Mounting Plate with Two or Four Fans
- Lift Off Side Panels with Key lock
- Cable Inlet from Top & Bottom
- 2 pair of Caster Wheel for Transportation
- Static load : 400-600 kg
- Color BLACK RAL 9005 or Gray RAL 7035
- Gamma cabinets are Electrostatic Powder Coated Finish
- Gamma Cabinets Comply with EIA – 310 E & 310 D





GAMMA NET FREE STAND RACK CABINETS SIZE 18U – 22U – 26 U

Part Number	Description - Standard Configuration - Colour Black RAL 9005 (WELDED STRUCTURE)	Width (W) mm	Depth (D) mm	Height (H) mm	Depth Rail to Rail (mm)	Static Load (KG)
GMC-FR-18U-66-2F	Gamma Net Free Stand Cabinet 18U 600x600 with Removable Side Door , Front Glass , Metal Back door , 2 pair of 19" Adjustable Pillars , 2 pair of caster Wheels , 2 Fan	600	600	900	500	400
GMC-FR-18U-68-2F	Gamma Net Free Stand Cabinet 18U 600x800 with Removable Side Door , Front Glass , Metal Back door , 4 pair of 19" Adjustable Pillars , 2 pair of caster Wheels , 2 Fan	600	800	900	700	400
GMC-FR-18U-610-4F	Gamma Net Free Stand Cabinet 18U 600x1000 with Removable Side Door , Front Glass , Metal Back door , 2 pair of 19" Adjustable Pillars , 2 pair of caster Wheels , 4 Fan	600	1000	900	900	400
GMC-FR-18U-88-2F	Gamma Net Free Stand Cabinet 18U 800x800 with Removable Side Door , Front Glass , Metal Back door , 2 pair of 19" Adjustable Pillars , 2 pair of caster Wheels , 2 Fan	800	800	900	700	400
GMC-FR-18U-810-4F	Gamma Net Free Stand Cabinet 18U 800x1000 with Removable Side Door , Front Glass , Metal Back door , 2 pair of 19" Adjustable Pillars , 2 pair of caster Wheels , 4 Fan	800	1000	900	900	400
GMC-FR-22U-66-2F	Gamma Net Free Stand Cabinet 22U 600x600 with Removable Side Door , Front Door Glass , Metal Back door , 2 pair of 19" Adjustable Mounting Pillars , 2 pair of caster Wheels , 2 Fan	600	600	1000	700	600
GMC-FR-22U-68-2F	Gamma Net Free Stand Cabinet 22U 600x800 with Removable Side Door , Front Door Glass , Metal Back door , 2 pair of 19" Adjustable Pillars , 2 pair of caster Wheels , 2 Fan	600	800	1000	900	600
GMC-FR-22U-610-2F	Gamma Net Free Stand Cabinet 22U 600x1000 with Removable Side Door , Front Glass , Metal Back door , 2 pair of 19" Adjustable Pillars , 2 pair of caster Wheels , 2 Fan	600	1000	1000	900	600
GMC-FR-22U-88-2F	Gamma Net Free Stand Cabinet 22U 800x800 with Removable Side Door , Front Door Glass , Metal Back door , 2 pair of 19" Adjustable Mounting Pillars , 2 pair of caster Wheels , 2 Fan	800	800	1000	700	600
GMC-FR-22U-810-2F	Gamma Net Free Stand Cabinet 22U 800x1000 with Removable Side Door , Front Door Glass , Metal Back door , 2 pair of 19" Adjustable Pillars , 2 pair of caster Wheels , 2 Fan	800	1000	1000	900	600
GMC-FR-26U-66-2F	Gamma Net Free Stand Cabinet 26U 600x600 with Removable Side Door , Front Door Glass , Metal Back door , 2 pair of 19" Adjustable Pillars , 2 pair of caster Wheels , 2 Fan	600	600	1200	500	600
GMC-FR-26U-68-2F	Gamma Net Free Stand Cabinet 26U 600x800 with Removable Side Door , Front Door Glass , Metal Back door , 2 pair of 19" Adjustable Mounting Pillars , 2 pair of caster Wheels , 2 Fan	600	800	1200	700	600
GMC-FR-26U-610-2F	Gamma Net Free Stand Cabinet 26U 600x1000 with Removable Side Door , Front Door Glass , Metal Back door , 2 pair of 19" Adjustable Mounting Pillars , 2 pair of caster Wheels , 2 Fan	600	1000	1200	900	600
GMC-FR-26U-88-2F	Gamma Net Free Stand Cabinet 26U 800x800 with Removable Side Door , Front Door Glass , Metal Back door , 2 pair of 19" Adjustable Pillars , 2 pair of caster Wheels , 2 Fan	800	800	1200	700	600
GMC-FR-26U-810-4F	Gamma Net Free Stand Cabinet 26U 800x1000 with Removable Side Door , Front Door Glass , Metal Back door , 2 pair of 19" Adjustable Pillars , 2 pair of caster Wheels , 4 Fan	800	1000	1200	900	600

OTHER SIZES AVAILABLE ON REQUEST



GAMMA NET FREE STAND RACK CABINETS DRAWING – GLASS DOORS

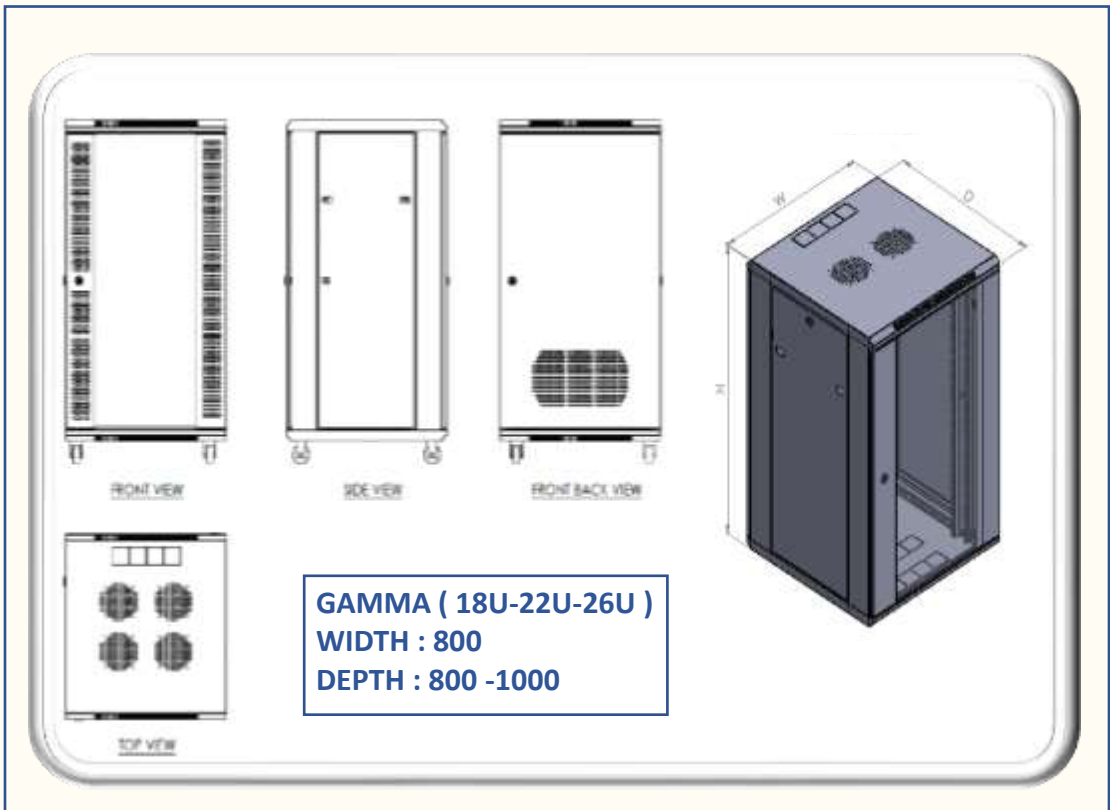
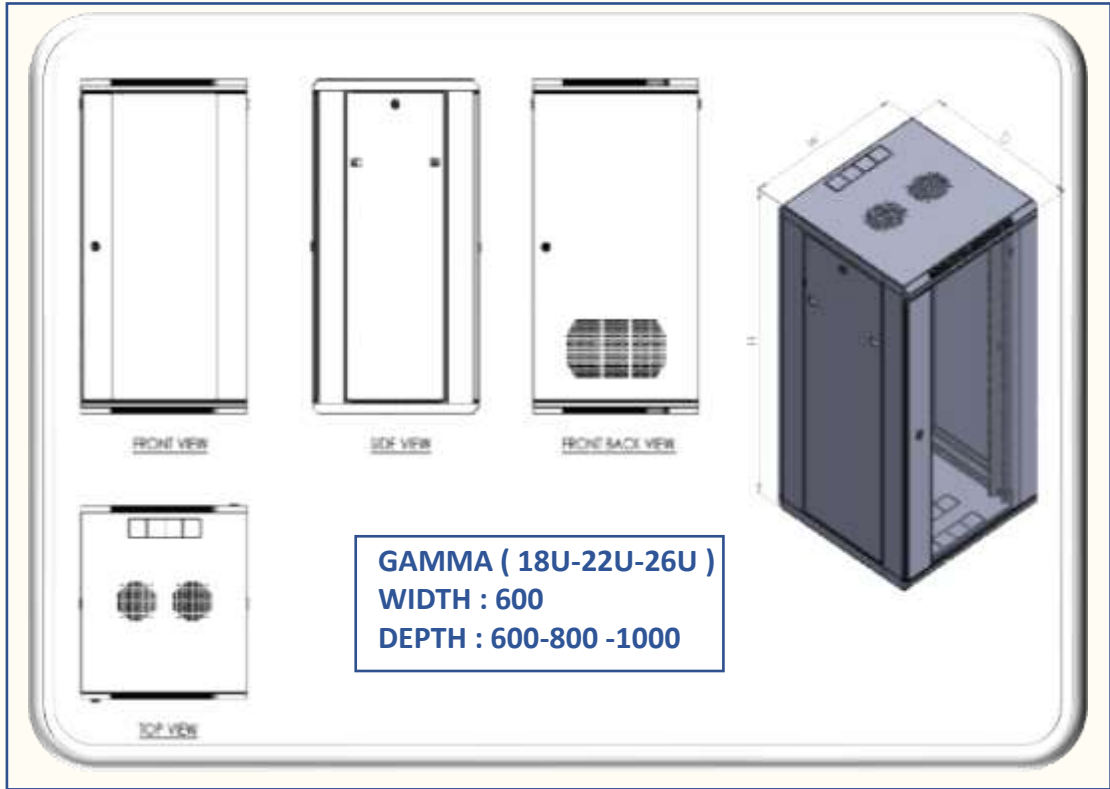



GAMMA NET FREE STAND RACK CABINETS DRAWING – PERFORATED DOORS

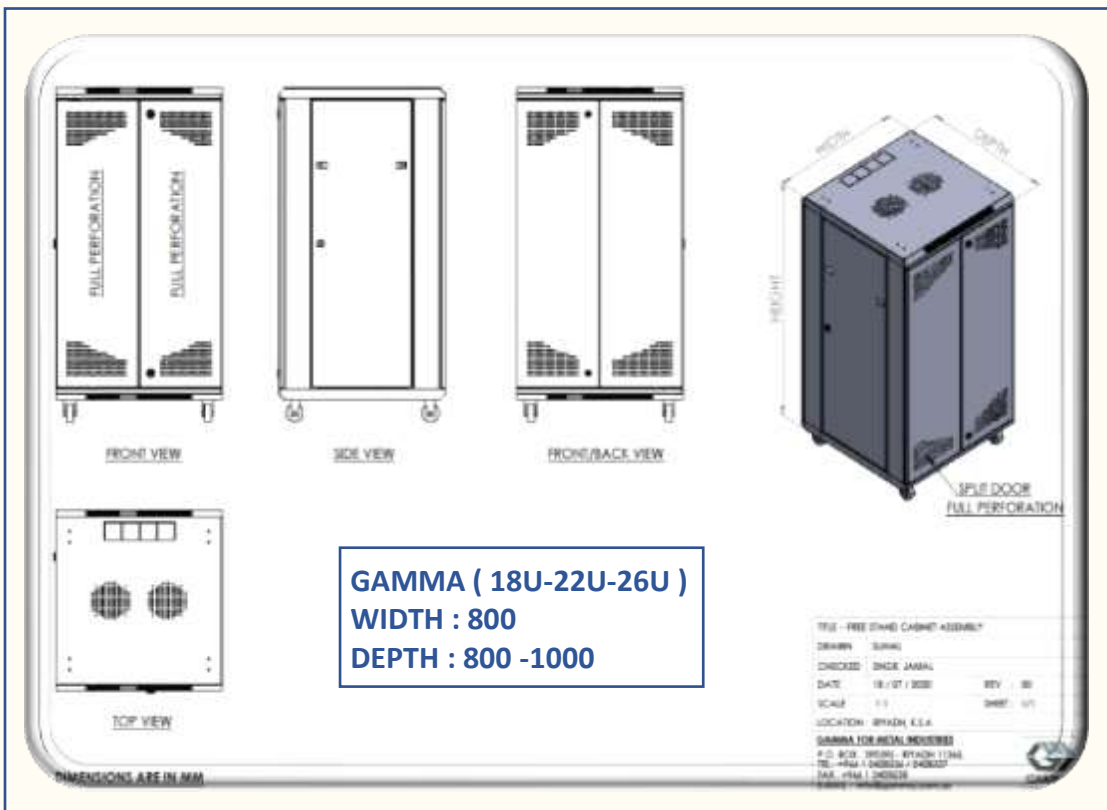
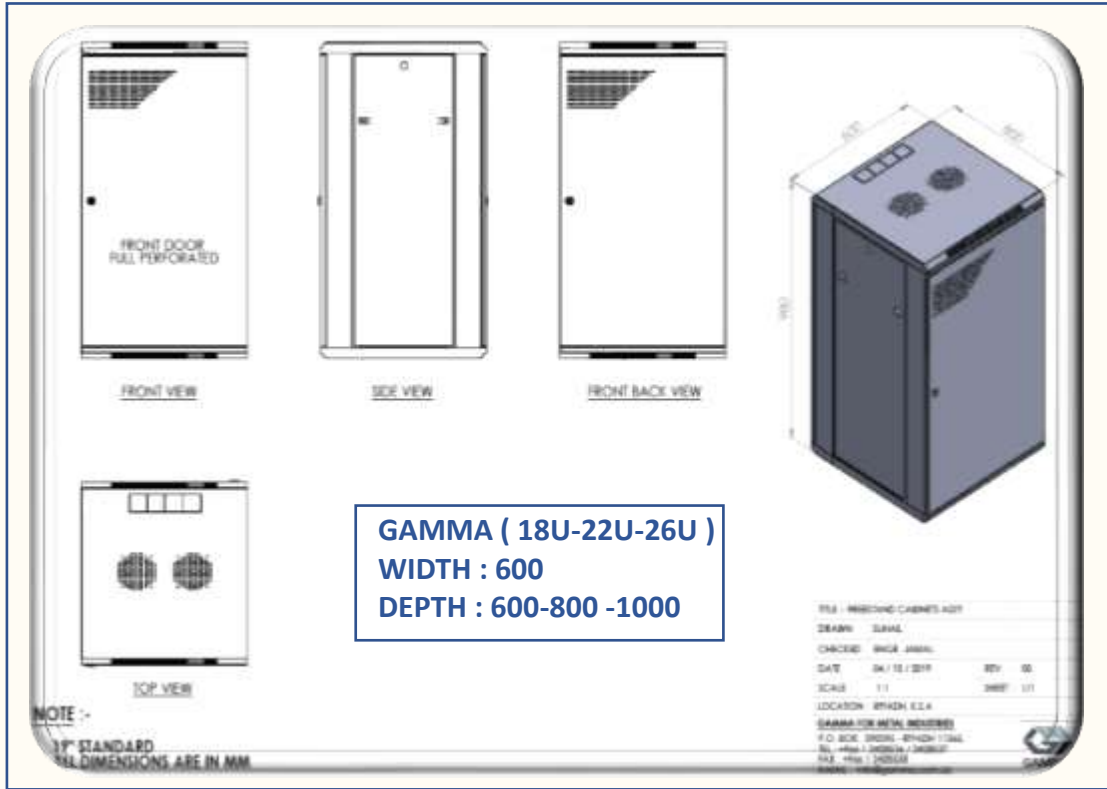



GAMMA NET WALL MOUNT RACK CABINETS (6U-9U-12U-15U-21U)





GAMMA NET WALL MOUNT RACK CABINETS (6U-9U-12U-15U-21U)

Standard Dimensions :

Height : 6U TO 21U
Width : 600
Depth : 450-600-800 mm

Standard Colour :

RAL 9005 BLACK 
RAL 7035 Light Gray 
Other colours available on request   

Complying with International Standards:

- ISO 9001-2015 • ISO 14001:2015 • EIA/ECA- 310 E & EIA-310 D
- IEC 297-1 19" MOUNTING • IEC 297-2 Overall cabinet dimensions • IP20 Protected



Gamma Wall Mounted Single & Double Section Cabinets

Features:

- Rigid Welded Steel Frame
- Structure made from steel sheet
- Ventillation Slots in Front and Side. 1 or 2 Fans are equipped as standard.
- Hinged Cabinet Body can Open 120 Degrees and secured to wall mount section by lock and key for double section cabinet.
- Wall mount cabinet has cable access panels top and bottom.
- 4 pair of L-Shape Mounting Rails and Rail Depth can adjust in 25mm increments.
- 6mm Tempered Glass Door Provides full view of equipment with full, 180 degrees opening and can easily removed and complete with lock and key.
- Pair of solid Side Side Panels are removable with latches or lock.
- High quality, powder coat finish black 9005 or gray 7035
- Gamma cabinets comply with EIA-310-D 19" Standard.





GAMMA NET WALL MOUNT RACK CABINETS (6U-9U-12U-15U-21U)

Part Number	Description - Standard Configuration - Colour Black RAL 9005	Width (W) mm	Depth (D) mm	Height (H) mm	Depth Rail to Rail (mm)	Static Load (KG)
GMC-WMS-6U-645-1F	Gamma Net Wall Mount Cabinet 6U 600x450 with Removable Side Door , Front Glass , 2 pair of 19" Adjustable Pillars , 1 Fan	600	450	365	350	40
GMC-WMS-9U-645-1F	Gamma Net Wall Mount Cabinet 9U 600x450 with Removable Side Door , Front Glass , 2 pair of 19" Adjustable Pillars , 1 Fan	600	450	495	350	40
GMC-WMS-12U-645-1F	Gamma Net Wall Mount Cabinet 12U 600x450 with Removable Side Door , Front Glass , 2 pair of 19" Adjustable Pillars , 1 Fan	600	450	630	350	60
GMC-WMS-15U-645-2F	Gamma Net Wall Mount Cabinet 15U 600x450 with Removable Side Door , Front Glass , 2 pair of 19" Adjustable Pillars , 2 Fan	600	450	760	350	60
GMC-WMS-21U-645-2F	Gamma Net Wall Mount Cabinet 21U 600x450 with Removable Side Door , Front Glass , 2 pair of 19" Adjustable Pillars , 2 Fan	600	450	1000	350	60
GMC-WMS-6U-66-1F	Gamma Net Wall Mount Cabinet 6U 600x600 with Removable Side Door , Front Glass , 2 pair of 19" Adjustable Pillars , 1 Fan	600	600	365	350	40
GMC-WMS-9U-66-1F	Gamma Net Wall Mount Cabinet 9U 600x600 with Removable Side Door , Front Glass , 2 pair of 19" Adjustable Pillars , 1 Fan	600	600	495	500	40
GMC-WMS-12U-66-1F	Gamma Net Wall Mount Cabinet 12U 600x600 with Removable Side Door , Front Glass , 2 pair of 19" Adjustable Pillars , 1 Fan	600	600	630	500	60
GMC-WMS-15U-66-2F	Gamma Net Wall Mount Cabinet 15U 600x600 with Removable Side Door , Front Glass , 2 pair of 19" Adjustable Pillars , 2 Fan	600	600	760	500	60
GMC-WMS-21U-66-2F	Gamma Net Wall Mount Cabinet 21U 600x600 with Removable Side Door , Front Glass , 2 pair of 19" Adjustable Pillars , 2 Fan	600	800	1000	500	60
GMC-WMS-6U-68-2F	Gamma Net Wall Mount Cabinet 6U 600x800 with Removable Side Door , Front Glass , 2 pair of 19" Adjustable Pillars , 2 Fan	600	800	365	700	40
GMC-WMS-9U-68-2F	Gamma Net Wall Mount Cabinet 9U 600x800 with Removable Side Door , Front Glass , 2 pair of 19" Adjustable Pillars , 2 Fan	600	800	495	700	40
GMC-WMS-12U-68-2F	Gamma Net Wall Mount Cabinet 12U 600x800 with Removable Side Door , Front Glass , 2 pair of 19" Adjustable Pillars , 2 Fan	600	800	630	700	60
GMC-WMS-15U-68-2F	Gamma Net Wall Mount Cabinet 15U 600x800 with Removable Side Door , Front Glass , 2 pair of 19" Adjustable Pillars , 2 Fan	600	800	760	700	60
GMC-WMS-21U-68-2F	Gamma Net Wall Mount Cabinet 21U 600x800 with Removable Side Door , Front Glass , 2 pair of 19" Adjustable Pillars , 2 Fan	600	800	1000	700	60

DOUBLE SECTION WALL MOUNT

GMC-WMD-6U-6510-2F	Gamma Net Wall Mount Double Section Cabinet 6U 600x500 +100 with Fixed Side Door , Front Glass , 2 pair of 19" Adjustable Pillars , 2 Fan	600	500 +100	365	700	40
GMC-WMD-9U-6510-2F	Gamma Net Wall Mount Double Section Cabinet 9U 600x500 +100 with Fixed Side Door , Front Glass , 2 pair of 19" Adjustable Pillars , 2 Fan	600	500 +100	495	700	40
GMC-WMD-12U-6510-2F	Gamma Net Wall Mount Double Section Cabinet 12U 600x500 +100 with Fixed Side Door , Front Glass , 2 pair of 19" Adjustable Pillars , 2 Fan	600	500 +100	630	700	60
GMC-WMD-15U-6510-2F	Gamma Net Wall Mount Double Section Cabinet 15U 600x500 +100 with Fixed Side Door , Front Glass , 2 pair of 19" Adjustable Pillars , 2 Fan	600	500 +100	760	700	60



GAMMA WALL MOUNT RACK CABINETS DRAWING – GLASS DOORS

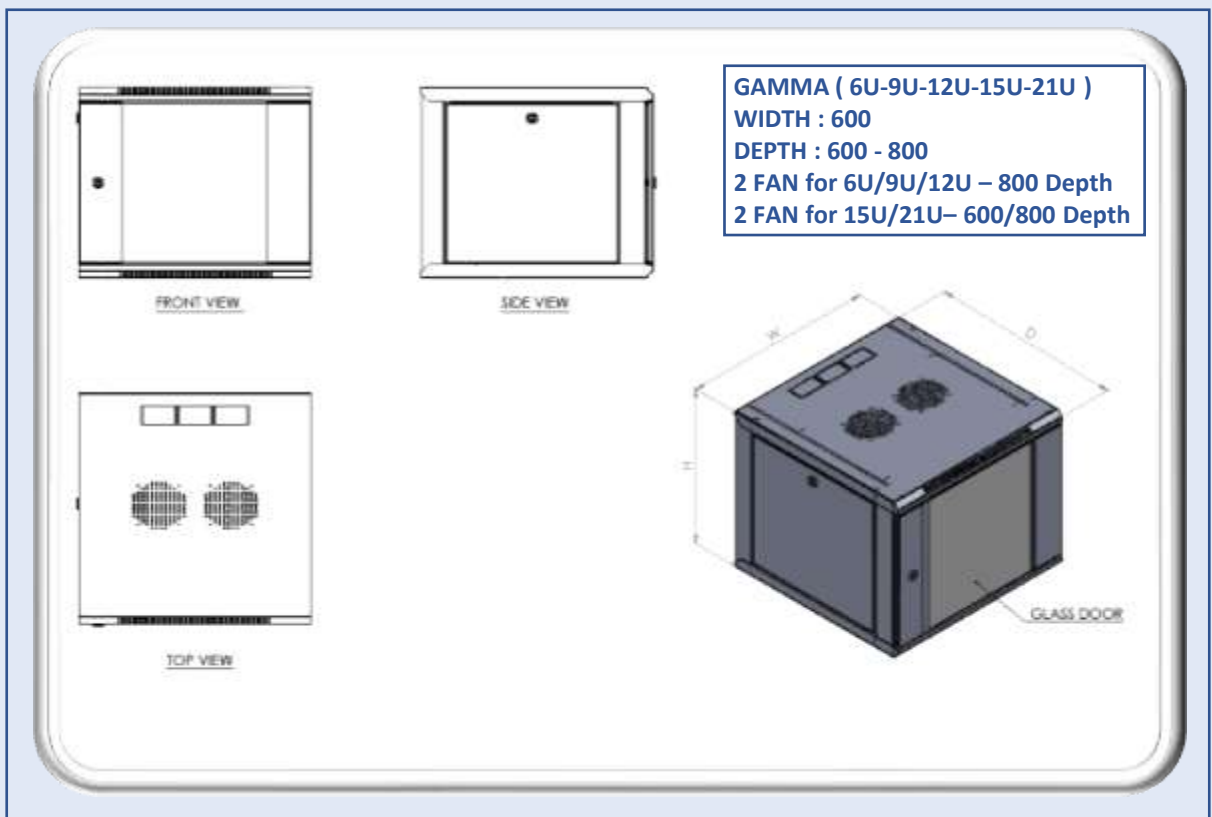
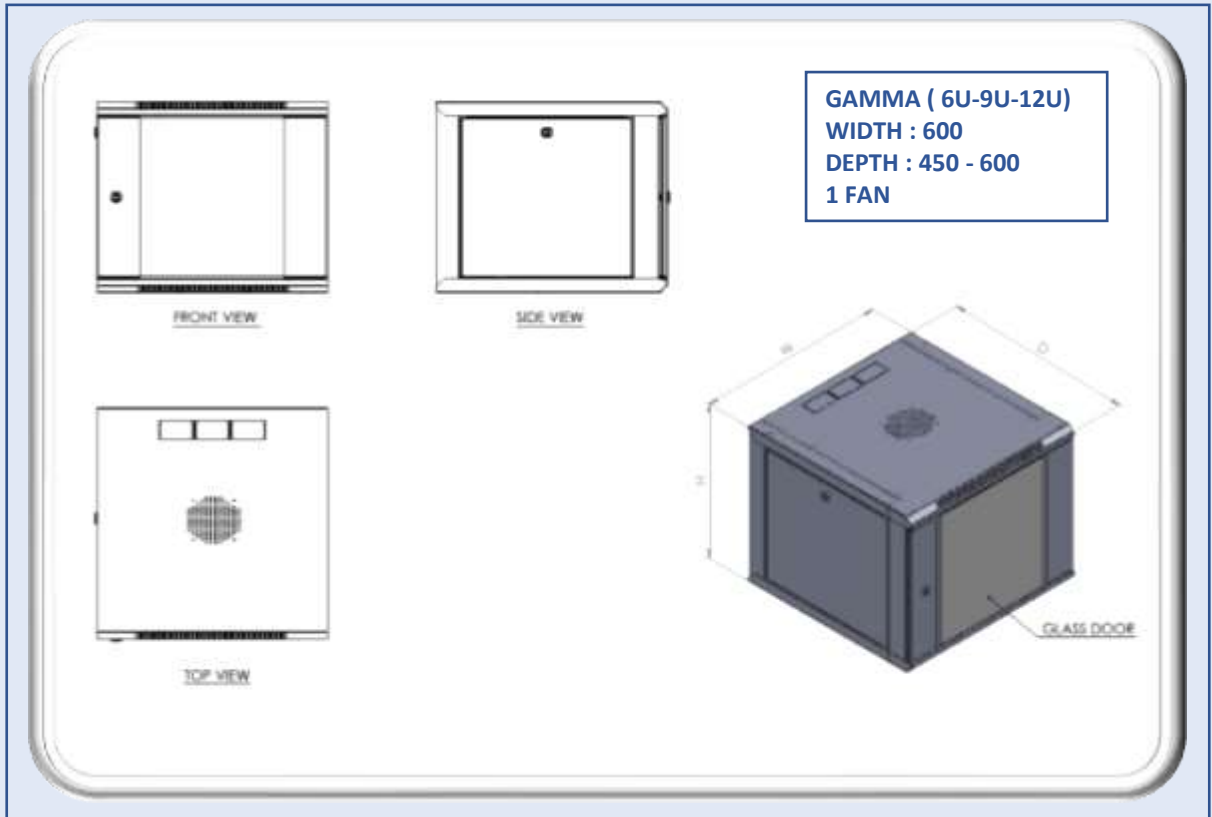



GAMMA NET AXIAL FAN DATA SHEET

GAMMA FACTORY FOR METAL INDUSTRIES
GAMMA AXIAL FAN

FRONT VIEW

SIDE VIEW

TOP VIEW

FAN WIRE

FAN TECHNICAL DATA

FAN SIZE : 119 X 119 X 38 mm
VOLTAGE : 220 VOLTS
AIR VOLUME : 105 CFM
FREQUENCY : 60 HZ
CURRENT : 0.14 AMP

Ventilation Calculation:

- a. 1 KW = 3,413.0 BTU/HR
- b. 3.5 KW = 11,945.5 BTU
- c. 12,000 BTU = 1 TON of air conditioning
- d. 11,942 BTU = 0.9952 TON of air-conditioning
- e. 1 Ton of Air Conditional = 400 CFM
- f. 3.5 KW = ~ 398.1 CFM
- g. **1 FAN = 105 CFM ,**
4 FANS = 420 CFM ~ 3.69 KW heat Dissipation

REF : GAM-0204MKT
DRAWN : GAMMA
CHECKED : INGA (mm)
DATE : 01/13/2014
SCALE : 1:1
LOCATION : WYDHA S.S.P.
GAMMA FOR METAL INDUSTRIES
P.O. BOX 38070, RIYADH 11508
TEL : +966 11 2620081 112620082
FAX : +966 11 2620080



GAMMA Ventilation Fan Calculation

GAMMA Ventilation Calculation as below clarifications :

- a. 1 KW = 3,413.0 BTU/HR
- b. 3.5 KW = 11,945.5 BTU
- c. 12,000 BTU = 1 TON of air conditioning
- d. 11,942 BTU = 0.9952 TON of air-conditioning
- e. 1 Ton of Air Conditional = 400 CFM
- f. 3.5 KW = ~ 398.1 CFM
- g. **1 FAN = 105 CFM , 4 FANS = 420 CFM ~ 3.69 KW heat Dissipation**

We hereby confirm that our 4 Fans will be enough for 3.5 KW heat



GAMMA NET OPEN Rack









GAMMA NET OPEN RACK CABINETS – 2 or 4 POLE (22U-47U)

Standard Dimensions :

Height : 22U – 47U
Width : 510 - 600 mm
Depth : 100

Standard Colour :

RAL 9005 BLACK 
RAL 7035 Light Gray 
Other colours available on request   

Complying with International Standards:

- ISO 9001 : 2015
- ISO 14001 : 2015
- EIA/ECA- 310 E & EIA-310 D
- IEC 297-1 19" MOUNTING
- IEC 297-2 Overall cabinet dimensions
- IP20 Protected



Features

- Frame Made from Welded Steel
- Powder Coated Finish
- Size from 21U – 47 U
- 19" 2 Pole Frame or 4 Pole
- Static load 300 kg
- Base for ground fixing
- Optional Bus Bar for Earthing
- Optional Vertical cable Management at side
- Optional Transportation wheel
- Optional Cantilever Shelf
- Color Black RAL 9005 or Gray RAL 7035
- Other color available on Request
- Made in Saudi Arabia



Open Rack	H	h	W	w
22 U	1125	22 U	514	450
36 U	1747	36 U	514	450
42 U	2013	42 U	514	450
45 U	2147	45 U	514	450

Abbreviations : **H**- Overall Height, **h**- Usable Height, **W** Overall Width, **w** Usable width, 1U = 44.45MM



GAMMA Power Distribution Unit –PDU

PDU – UK TYPE Data

Volts : 220 Volt / 60 Hz

AMPS Inlet : 13 amps

Number of Outlet Socket : 19" Standard (4 / 6 / 8 / Way UK TYPE 13 AMPS)

Inlet Socket : 13 amps UK

16 amps US Main Plug or Industrial Plug

32 amps Industrial Plug , Max. 4 Way

Case : Aluminum Housing

Standard : Horizontal 19" standard

Power Cord : 1.8 m

Country Of origin : SAUDI ARABIA

Brand : GAMMA

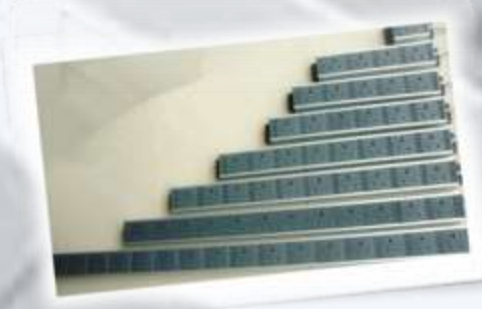
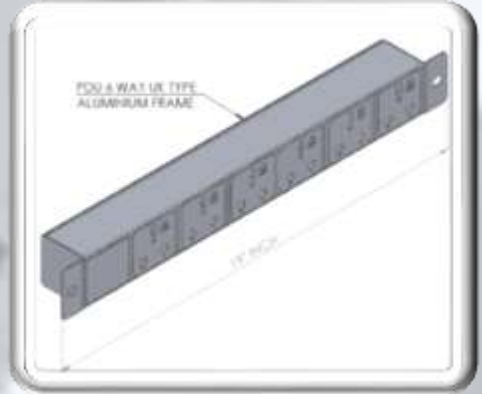

PDU – C13-C19 TYPE Data

Volts : 220 Volt / 60 Hz

AMPS Inlet : 10 amps

Number of Outlet Socket : (24 X C13 + 4 X C19)

Braker : 16 amps or 32 amps braker

Inlet Socket :

16 amps Industrial Plug

32 amps Industrial Plug

Case : Metal Housing

Power Cord : 1.8 m

Country Of origin : SAUDI ARABIA

Brand : GAMMA

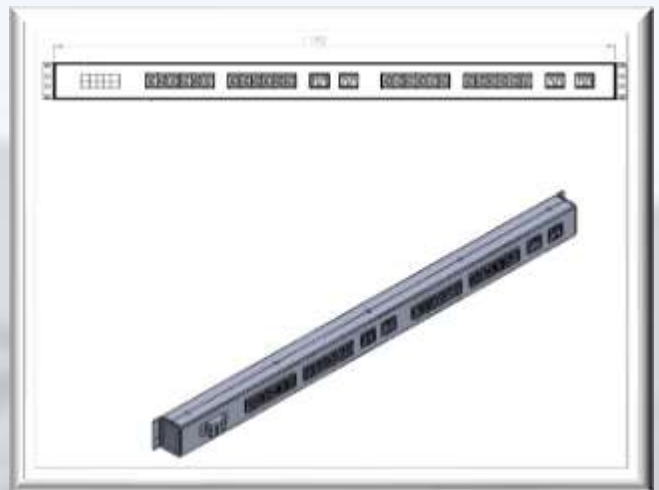



GAMMA NET RACK CABINETS OPTIONS

Part Number	Description
GMC-SDP-F	Single Door Perforated Front
GMC-SDP-B	Single Door Perforated back
GMC-DDP-F	Double Door Perforated Front
GMC-DDP-B	Double Door Perforated Back
GMC-DDP-B	Double Door Perforated Front
GMC-DDP-B	Double Door Perforated Back
GMC-VCM	Vertical Cable Management for 800 W
GMC-EBB	Earthing Bus Bar – 19” rack mounted
GMC-TH-M	Thermostat for Fans -Mechanical
GMC-EK	Earthing Kit – 10 pcs/set
GMC-HCO	Horizontal Cable Organizer – 19” Mount
GMC-PS	Perforated Side Doors
GMC-GN	Gauge Nut – 20 pcs/set
GMC-FS	Fixed Shelves
GMC-SLS	Sliding Shelf
GMC-7035	Colour Light Gray RAL 7035
GMC-SCOLR	Colour Special
GMC-BP-1U	1U Blank Panel
GMC-BP-2U	2U Blank Panel
GMC-GP	Gland Plate for base covering
GMC-PDU-UK-6W-13A	PDU 6 Way UK type 13 Amps
GMC-PDU-UK-6W-16A	PDU 6 Way UK type 16 Amps
GMC-C13-C19-16A	Vertical PDU C13 X 24 , C19 X 4 , 16 A
GMC-C13-C19-32A	Vertical PDU C13 X 24 , C19 X 4 , 32 A

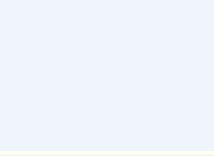
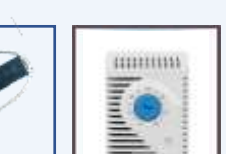



GAMMA NET OUTDOOR IP RACK CABINETS





GAMMA NET OUTDOOR IP RACK CABINETS (Custom Design)

Standard Dimensions :

Mount Type : Floor , Wall or Pole Type

Height : 6U TO 27U

Width : 250 to 700 , **Depth :** 150 to 800 mm

Standard Colour :

RAL 7035 Light Gray

Other colours available on request



Complying with International Standards:

- ISO 9001: 2015
- ISO 14001:2015
- EIA/ECA- 310 E & EIA-310 D
- IEC 297-1 19" MOUNTING
- IEC 297-2 Overall cabinet dimensions
- IP54/65/66 Protected

GAMMA NEW GENERATION SECURITY OUTDOOR CABINET – IP Protection

1.0 Gamma Outdoor General Features :

Security Cabinet:

GAMMA Security Cabinets with Pole mount version enable protecting your valuable and sensitive equipment's with its unique design. It is well protected against rain, snow, wind, sun radiation With its perfect resistance against to corrosion, protects your technological investments against environmental effects. Overall, between the inner and outer skin there is an Optional isolation rubber material or Aluminium foil to prevent skin heat to go inside cabinet

Optional isolated Skin Structure: Isolated Skin protects the equipment's inside cabinet from external effects, and harsh environmental conditions.

Cabinet Structure: Structure made from Sabic Galvanized steel material, with high corrosion resistance G90 protection and polyester outdoor electrostatic painting applied.

Filter and Fan System: The cabinet has a replaceable 1 or 2 filter housing at right side , which eliminates water and dust entry while allowing fresh air entry to the cabinet. The left side of the cabinet is equipped with 1 or 2 fan with filters. The Single cycle fan system allows fresh air entry from right side and discharge from left side accumulated heat from the ventilation filters back of the fans .

Optional Canopy Rain at top of the cabinet for double protection from rain

Painting: Outdoor style polyester paint applied to resist environmental corrosive effects. It also resists to sun radiation. Standard applied colour is RAL7035 Light Grey.

Optional Louver Cover for IP66 in both cabinet side louver cover are attached in left and right side over the fans and filters with 100 mm Gap for IP66 protection

Easy Floor /wall or Pole Assembly: Special designed wall/pole assembly heavy bracket at top and base allows the cabinet easy to be hanged over the wall/ pole special welded Plate in the pole with screws .Base Plinth for free stand

Front Door Structure and Lock System: Hidden 3 hinge, fixed on front door or key lock depend on cabinet size . With the standard 3 Points locking system handle and gasket, the front door provides maximum safety and sealing when the door is closed.. It has a sealing gasket structure, provides excellent IP protection even cold / hot weather condition.

Mounting Plate : Mounting Plate easy to install at back with 4 screws or 19" Mounting Pillars are provided according to cabinet design





GAMMA NET OUTDOOR IP RACK CABINETS (Custom Design)

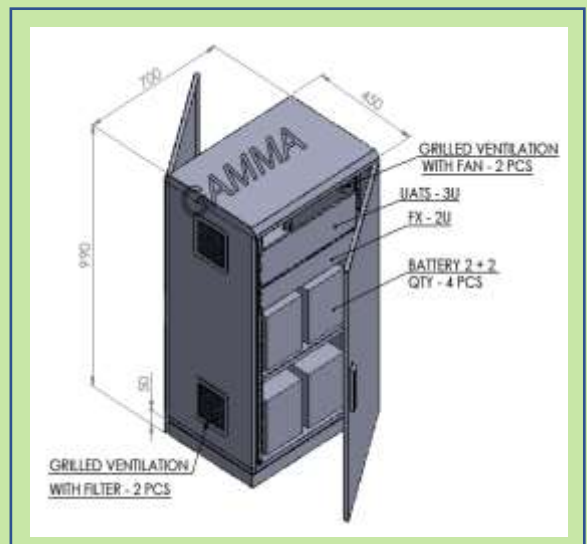
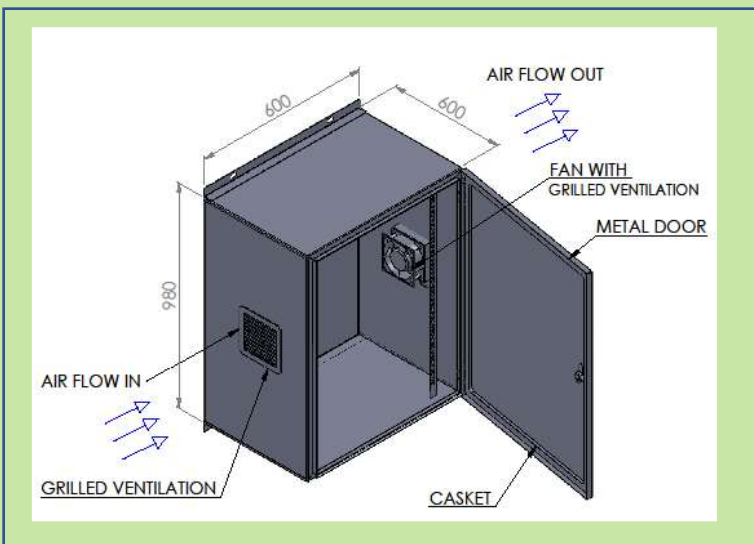
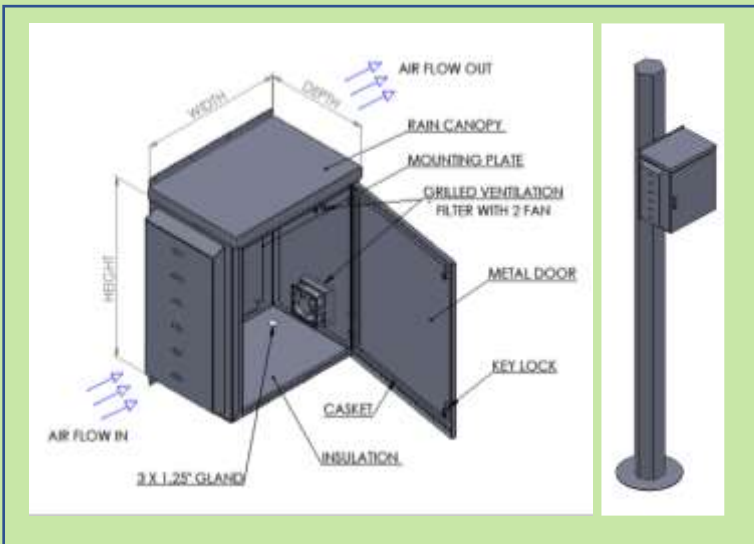
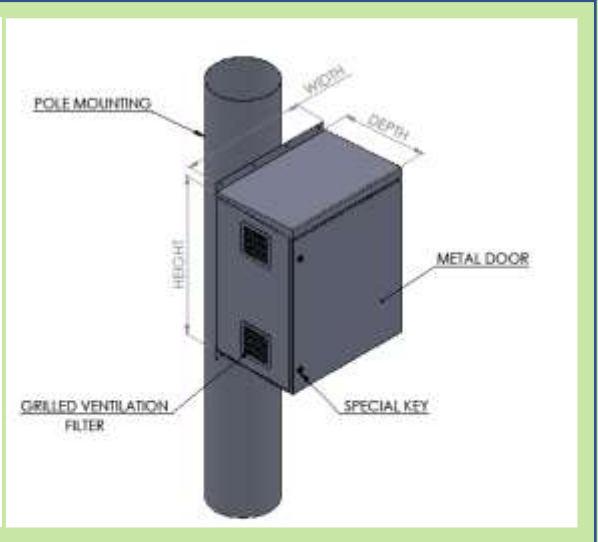
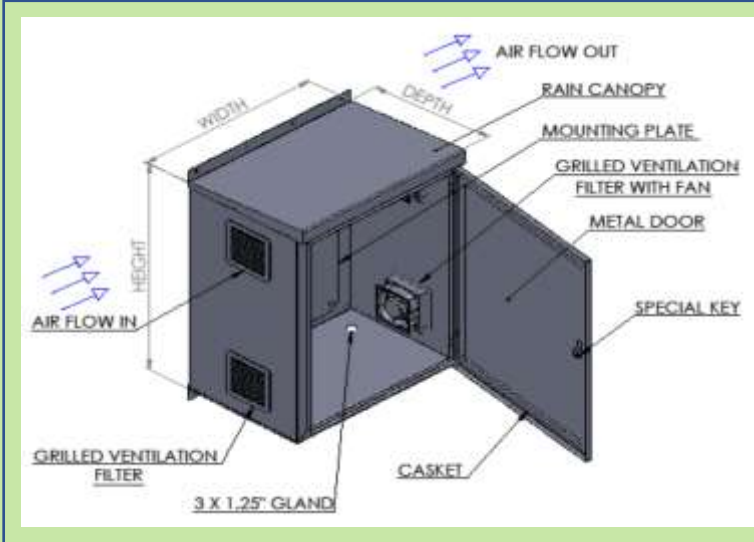



GAMMA NET OUTDOOR IP RATED SIZE

GAMMA NET OUTDOOR IP RATED WALL/Pole Metal Enclosures

Part Number	Standard Description (W X H X D) mm	MP SIZE (WXH) mm	Depth (D)
GMC-OD-WMS-3040-15	Wall mounting steel enclosures size 300X400X150 1 door IP 65 with MP	220 X 320	150
GMC-OD-WMS-3060-15	Wall mounting steel enclosures size 300X600X150 1 door IP 65 with MP	220 x 520	150
GMC-OD-WMS-4060-20	Wall mounting steel enclosures size 400X600X200 1 door IP 65 with MP	320 x 520	200
GMC-OD-WMS-4060-20-1F	Wall mounting steel enclosures size 400X600X200 1 door IP 65 with MP - 1 FAN	300 x 520	200
GMC-OD-WMS-4080-20	Wall mounting steel enclosures size 400X800X200 1 door IP 65 with MP	320 x 720	200
GMC-OD-WMS-4080-20-1F	Wall mounting steel enclosures size 400X800X200 1 door IP 65 with MP - 1 FAN	330 x 720	200
GMC-OD-WMS-6060-25	Wall mounting steel enclosures size 600X600X250 1 door IP 65 with MP	520 x 500	250
GMC-OD-WMS-6060-25-1F	Wall mounting steel enclosures size 600X600X250 1 door IP 65 with MP - 1 FAN	500 x 500	250
GMC-OD-WMS-6080-25	Wall mounting steel enclosures size 600X800X250 1 door IP 65 with MP	520 x 720	250
GMC-OD-WMS-6080-25-2F	Wall mounting steel enclosures size 600X800X250 1 door IP 65 with MP - 1 FAN	500 x 720	250
GMC-OD-WMS-6060-30	Wall mounting steel enclosures size 600X600X300 1 door IP 65 with MP	520 x 520	300
GMC-OD-WMS-6060-30-2F	Wall mounting steel enclosures size 600X600X300 1 door IP 65 with MP - 1 FAN	500 x 520	300
GMC-OD-WMS-6080-30	Wall mounting steel enclosures size 600X800X300 1 door IP 65 with MP	520 x 720	300
GMC-OD-WMS-6080-30-2F	Wall mounting steel enclosures size 600X800X300 1 door IP 65 with MP - 1 FAN	500 x 720	300

GAMMA NET OUTDOOR IP RATED 19" Wall /Pole Mount Metal Enclosures

Part Number	Standard Description (W X H X D) mm	Depth (D)
GMC-OD-WMS-6U-66-1F	6U Wall mounting steel enclosures size 600X600 1 door IP 65 with 4 19 inch Pillars – 1 Fan	600
GMC-OD-WMS-6U-68-1F	6U Wall mounting steel enclosures size 600X800 1 door IP 65 with 4 19 inch Pillars – 1 Fan	800
GMC-OD-WMS-9U-66-1F	9U Wall mounting steel enclosures size 600X600 1 door IP 65 with 4 19 inch Pillars – 1 Fan	600
GMC-OD-WMS-9U-68-1F	9U Wall mounting steel enclosures size 600X800 1 door IP 65 with 4 19 inch Pillars – 1 Fan	800
GMC-OD-WMS-12U-66-1F	12U Wall mounting steel enclosures size 600X600 1 door IP 65 with 4 19 inch Pillars – 1 Fan	600
GMC-OD-WMS-12U-68-1F	12U Wall mounting steel enclosures size 600X800 1 door IP 65 with 4 19 inch Pillars – 1 Fan	800
GMC-OD-WMS-15U-66-1F	15U Wall mounting steel enclosures size 600X600 1 door IP 65 with 4 19 inch Pillars – 1 Fan	600
GMC-OD-WMS-15U-68-2F	15U Wall mounting steel enclosures size 600X800 1 door IP 65 with 4 19 inch Pillars – 2 Fan	800
GMC-OD-WMS-18U-66-1F	18U Wall mounting steel enclosures size 600X600 1 door IP 65 with 4 19 inch Pillars – 1 Fan	600
GMC-OD-WMS-18U-68-2F	18U Wall mounting steel enclosures size 600X800 1 door IP 65 with 4 19 inch Pillars – 1 Fan	800

GAMMA NET OUTDOOR IP RATED 19" Floor Stand Metal Enclosures

Part Number	Standard Description (W X H X D) mm	Depth (D)
GMC-OD-FS-6U-66-1F	6U Free Stand steel enclosures size 600X600 1 door IP 65 with 4 19 inch Pillars -Plinth 50 mm	600
GMC-OD-FS-6U-68-1F	6U Free Stand steel enclosures size 600X800 1 door IP 65 with 4 19 inch Pillars -Plinth 50 mm	800
GMC-OD-FS-9U-66-1F	9U Free Stand steel enclosures size 600X600 1 door IP 65 with 4 19 inch Pillars -Plinth 50 mm	600
GMC-OD-FS-9U-68-1F	9U Free Stand steel enclosures size 600X800 1 door IP 65 with 4 19 inch Pillars -Plinth 50 mm	800
GMC-OD-FS-12U-66-1F	12U Free Stand steel enclosures size 600X600 1 door IP 65 with 4 19 inch Pillars -Plinth 50 mm	600
GMC-OD-FS-12U-68-1F	12U Free Stand steel enclosures size 600X800 1 door IP 65 with 4 19 inch Pillars-Plinth 50 mm	800
GMC-OD-FS-15U-66-2F	15U Free Stand steel enclosures size 600X600 1 door IP 65 with 4 19 inch Pillars -Plinth 50 mm	600
GMC-OD-FS-15U-68-2F	15U Free Stand steel enclosures size 600X800 1 door IP 65 with 4 19 inch Pillars-Plinth 50 mm	800
GMC-OD-FS-20U-66-2F	20U Free Stand steel enclosures size 600X600 1 door IP 65 with 4 19 inch Pillars -Plinth 50 mm	600
GMC-OD-FS-20U-68-2F	20U Free Stand steel enclosures size 600X800 1 door IP 65 with 4 19 inch Pillars -Plinth 50 mm	800
GMC-OD-FS-24U-66-2F	24U Free Stand steel enclosures size 600X600 1 door IP 65 with 4 19 inch Pillars -Plinth 50 mm	600
GMC-OD-FS-24U-68-2F	24U Free Stand steel enclosures size 600X800 1 door IP 65 with 4 19 inch Pillars -Plinth 50 mm	800
GMC-OD-FS-27U-66-2F	27U Free Stand steel enclosures size 600X600 1 door IP 65 with 4 19 inch Pillars -Plinth 50 mm	600
GMC-OD-FS-27U-68-2F	27U Free Stand steel enclosures size 600X800 1 door IP 65 with 4 19 inch Pillars -Plinth 50 mm	800



GAMMA OD TEST REPORT –WATER PROOF



Test product : GAMMA OUTDOOR CABINETS IP66
Manufacturer : GAMMA FACTORY FOR METAL INDS. KSA
Cabinet Size : 500 X 700 X 250 mm
Cabinet Data Include : Rubber Inside Isolation
2 Fans with Filter,
2 Air Inlet Filters, Rain Canopy
Sabic Galvanized Steel GI –G90
Test Duration : 15 min
Test Type : High Pressure water from all Direction
Number of Water Nozzles : 76 Nozzles x 14 mm Water Pipe





GAMMA OD TEST REPORT –DUST PROOF

Test product : GAMMA OUTDOOR CABINETS IP66
 Manufacturer : GAMMA FACTORY FOR METAL INDS. KSA
 Cabinet Size : 500 X 700 X 250 mm
 Cabinet Data Include : Rubber Inside Isolation
 2 Fans with Filter,
 2 Air Inlet Filters, Rain Canopy
 Sabic Galvanized Steel GI –G90
 Test Duration : 30 min
 Test Type : Dust from all Direction
 Type of Dust : Powder coating Material RAL7032





GAMMA OD TEST REPORT - FAN TEST

Test product : GAMMA OUTDOOR CABINETS IP66
 Manufacturer : GAMMA FACTORY FOR METAL INDS. KSA
 Cabinet Size : 500 X 700 X 250 mm
 Cabinet Data Include : Rubber Inside Isolation
 2 Fans with Filter,
 2 Air Inlet Filters, Rain Canopy
 Sabic Galvanized Steel GI -G90

Test Duration : 60 min
 Test Type : Fan Heat Dissipation
 Heat Load : 200 Watt
 Test Room : Normal Room Environments

Enclosure without FAN

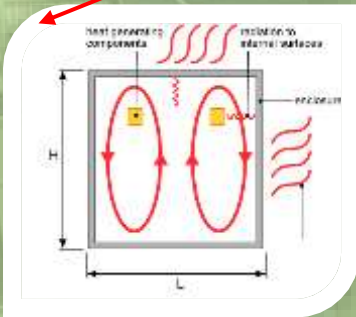

Enclosure with FAN

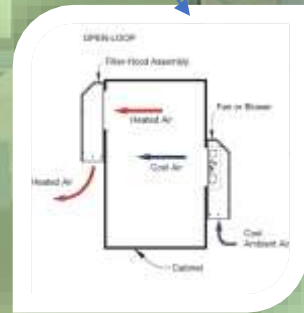

Heat Source OFF / Fan OFF
 Inside Temp. = 30 C
 Outside Temp. = 31 C

1



Heat Source ON / Fan OFF
 Inside Temp. = 40 C
 Duration : 15 min
 Outside Temp. = 30 C

2



Heat Source ON / Fan ON
 Inside Temp. = 37 C
 Duration : 10 min
 Outside Temp. = 31 C

3



Heat Source ON / Fan ON
 Inside Temp. = 34 C
 Duration : 15 min
 Outside Temp. = 31 C

4



Heat Source ON / Fan ON
 Inside Temp. = 32 C
 Duration : 5 min
 Outside Temp. = 32 C

5



Heat Source ON / Fan ON
 Inside Temp. = 33 C
 Duration : 5 min
 Outside Temp. = 33 C

6



GAMMA NET OUTDOOR IP Accessories Details

6. Axial Fan :

GAMMA FACTORY FOR METAL INDUSTRIES
GAMMA AXIAL FAN

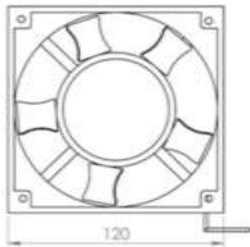

FRONT VIEW

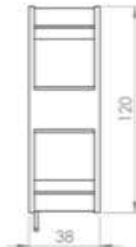

SIDE VIEW

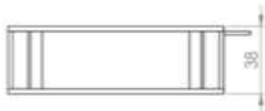

TOP VIEW

Axial Fan size 120 x 120 x 38 mm
Air Flow : 100 CFM
Power : 0.15 AMPS
Voltage : 48 VDC or 220 V /60Hz

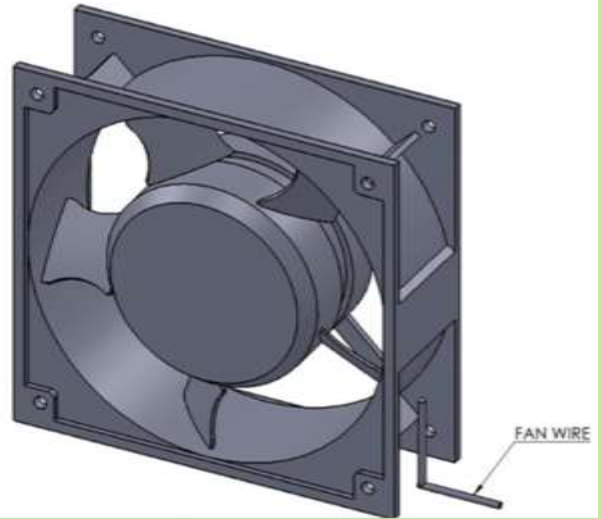

FAN WIRE

7. Air Filter :



Features	Unit	Filter unit
Air Flow Rate	m3/h	100
Dimensions	mm	160x160x31
Operating Temperature	C°	-10/+70
Plastic Material	-	ABS
Gasket	-	Polyurethane Sealing
Colour	-	Gray
Weight	kg	0,18
Mounting	-	Fast Clip-on



GAMMA NET OUTDOOR IP Accessories Details

1. Cable Duct :

Description

Open Slot PVC provides a lightweight self-extinguishing cable trunking with excellent rigidity and performance characteristics.. Recommended fixing method; rivets /Screws and washers.

Normal Size Inner (WXH)mm	Normal Size Outer (WXH)mm
25 x 50	28 x 53
50 x 75	54 x 78
50 x 50	54 x 54
50 x 75	55 x 79
50 x 100	56 x 105

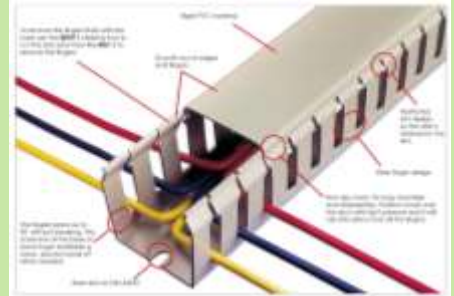

2. Din Rail

Description

Material : Galvanized Steel
Thickness : 1 mm
Length : 75 mm or as per Customer request

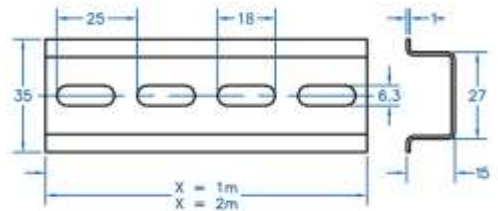

3. Rubber Insulation

Description :

Black Rubber sheet which can be use in outdoor Enclosures inside Insulation where resistance to atmospheric sunlight are required

Thickness : 2.5 mm
Hardness : +60/-7
Finish : Smooth
Density : 1.35 g/cm³
Tensile Strength : 5N/m²
Temperature : -30 / +100



4. Nickel Plated Cable Gland:

Nickel plated brass cable gland can hold cable firmly and have a wider cable range. It is resistant to salt water, weak acid, alcohol, oil, grease and common solvency.

Thread	Cable Range(mm)	OD (mm)	Spinner Size(mm)
PG13.5	6-12	30.4	12/23
PG18	10-14	22.5	24/25
PG18	10-14	25.0	24/27
PG21	13-18	28.1	30
PG25	15-22	32.0	35
PG28	18-25	37.0	40
PG36	25-35	42.0	50
PG42	32-38	54.0	57



5. Flexible Conduit Cable :

Flexible conduit is a kind of flexible metal conduit. It's double locked(interlocked)

Inner Diameter (mm)	Outer Diameter (mm)
25.0	24.3
32.0	24.7
38.0	25.0
45.0	26.0
52.0	26.0
60.0	26.0



Note :

Detail only for Customer/End user reference , Gamma Not responsible for suppling Trunk /Cable Gland / Flexible Cable Conduit or Din Rail



GAMMA NET OUTDOOR IP Accessories Details

10. MP Solid Galvanized :

Solid Galvanized Mounting Plate , easy to installed in back of the outdoor cabinets with 4 nut on the welded back stud

Optional Perforated Mounting Plate available on Request as an option



Mounting Plate Wiring Diagram Layout Example

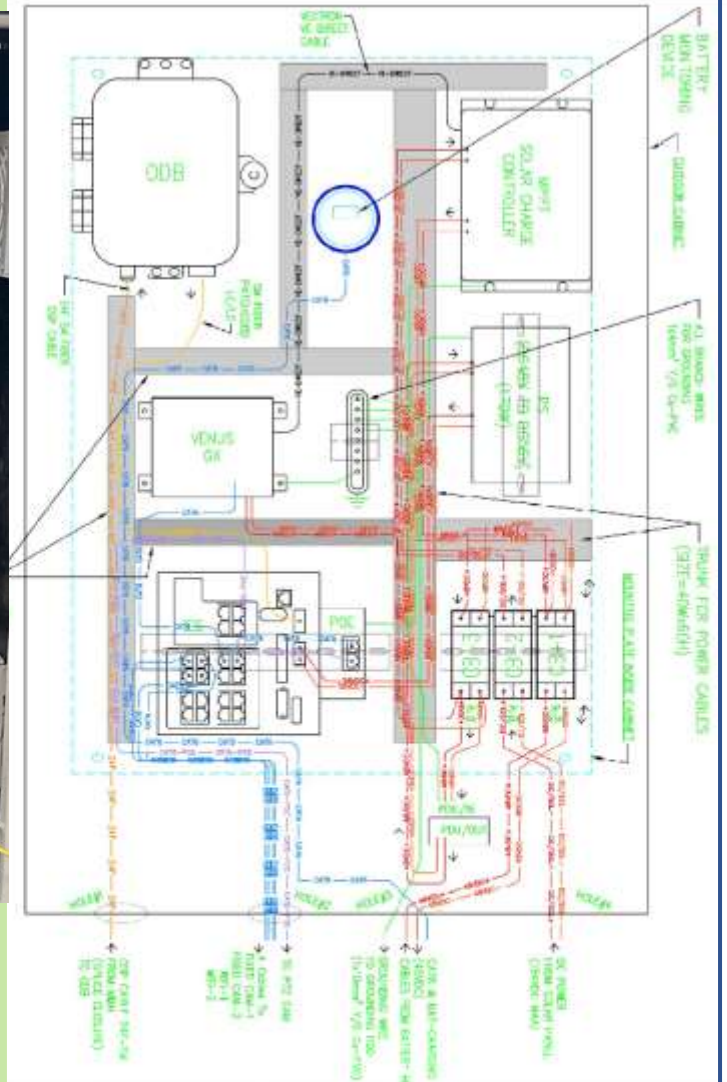

Note :

Customer/System Integrator responsible for Wiring Diagram Design in Mounting Plate Above Diagram only example for Clarification only



GAMMA NET OUTDOOR OPTIONS

Part Number	Description
GMC-PMP	Perforated Mounting Back Plate
GMC-EBB	Earthing Bus Bar – 19” rack mounted
GMC-TH-M	Thermostat for Fans -Mechanical
GMC-EK	Earthing Kit – 10 pcs/set
GMC-HCO	Horizontal Cable Organizer – 19” Mount
GMC-GN	Gauge Nut – 20 pcs/set
GMC-FS	Fixed Shelves
GMC-SLS	Sliding Shelf
GMC-CTS	Cantilever Shelf
GMC-BP-1U	1U Blank Panel
GMC-BP-2U	2U Blank Panel
GMC-PKIT-15	Pole Kit ring up to 150 mm steel Ring
GMC-RCAP	Rain Cap Cover
GMC-INS-R	Inside Rubber Isolation – 1mm
GMC-INS-AL	Inside Aluminium Film with Foam Isolation – 8 mm
GMC-DSPL	Door Switch Plate support
GMC-PDU-UK-4W-13A	PDU 4 Way UK type 13 Amps . Aluminium Case
GMC-PDU-UK-6W-13A	PDU 6 Way UK type 13 Amps . Aluminium Case
GMC-PDU-UK-6W-16A	PDU 6 Way UK type 16 Amps . Aluminium Case
GMC-DP	Documents Pocket
GMC-FAN-48DCV	Fan with 48 DC Volt
GMC-FAN-220V	FAN 220 Volts
GMC-FILTER	Filter for air Inlet
GMC-DNR	Din Rail Steel – 200





GAMMA NET BATTERY RACK AND CABINETS (Open Rack or Close Cabinet)





GAMMA BATTERY RACK CABINETS

Standard Dimensions :

Height : 1000 - 2500

Width : 600 - 800 mm

Depth : 600 - 1000 mm

Other Sizes available on request

Complying with International Standards:

- ISO 9001 : 2015
- ISO 14001 : 2015
- IP20 Protected – Other IP rated Available on Request

Standard Colour :

RAL 9005 BLACK

RAL 7035 Light Gray

Other colours available on request



TECHNICAL DATA

- Gamma Battery Racks – Welded Frame and Shelves
- Static Load up to 1800 kg -
- Shelf static load up to 350 Kg
- Removable Side Panels with perforated for air ventilation
- Removable Back and Front Door with ventilation
- Structure made from tubes 2.0 mm Thickness
- Welded Angles shelf 3.0 mm thickness with sheet cover
- 100 mm tube Legs
- Powder coated RAL 9005 Black or RAL 7035 Light Gray
- Cable inlet from all shelves
- Optional Braker plate
- Custom made design as per battery size and Quantity
- Made in Saudi Arabia
- IP 20 protected , other IP rated available on request



DIYAR
Saudi Diyar Consultants

Site Staff Comments

Subject: material submittal for Battery Rack

Page 1

Received Date : 01/8/2017

Issued Date: 06/8/2017

Contractor: ICAD

Project Title: land and marine perimeter security system

Project No.: JE/1527

Attachments: Pre-qualification, Catalogue, Technical data

Trans. Number:DT-ICAD-SALAM-MTS-0071

Date : 01/8/2017

Design drawings, specification, and site requirements have been used in the review with the following conducted remarks:-

Item No.	Comments	Recommended Code
	GAMMA is approved as a manufacture for Battery Rack subject to the Following:	
1.	The warranty shall be extended to become 10 years from the date of delivery against manufacture defects.	3
2.	Contractor shall submit the total number of batteries with the cataloges for each location of the UPS's with the final load for each UPS to achieve 4 hours as a back-up time for all UPS's taking in the consideration the loads of the distribution switches.	





GAMMA BATTERY RACKS

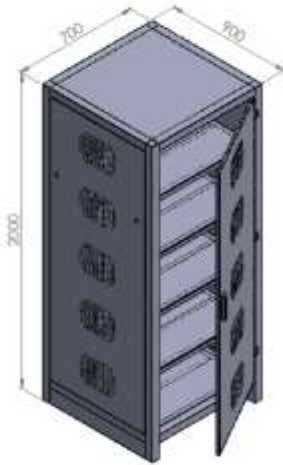

NOTE :- BATTERY SIZE
261 X 168 X 224.5
1 SHELF - 8 PCS BATTERY
5 SHELF - 40 PCS BATTERY



NOTE :- BATTERY SIZE
166 X 175 X 125
1 SHELF - 9 PCS BATTERY
4 SHELF - 36 PCS BATTERY



NOTE :- BATTERY SIZE
261 X 168 X 223
1 SHELF - 6 PCS BATTERY
4 SHELF - 24 PCS BATTERY

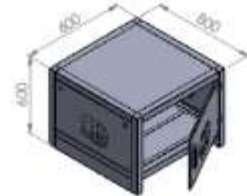

NOTE :- 350 X 168 X 225
1 SHELF - 3 PCS BATTERY

ALL DIMENSIONS ARE IN MM

TITLE :- BATTERY RACK ASSEMBLY

DRAWN	SURAJ
CHECKED	ENG. JAWAD
DATE	13 / 11 / 2020
SCALE	1:1
LOCATION	RIYADH, K.S.A
GAMMA FOR METAL INDUSTRIES	
P.O. BOX. 370395 - RIYADH 11366	
TEL: +966 1 2482534 / 2482537	
FAX: +966 1 2484536	
E-MAIL: info@gamma.com.sa	



GAMMA BATTERY CLOSED RACK

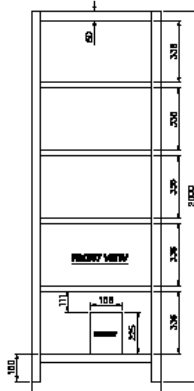
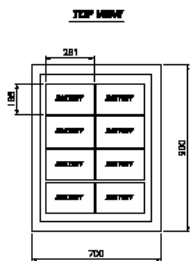

NOTE:- 261 X 168 X 224.5
5 SHELF - 40 PCS BATTERY
4 SHELF - 36 PCS BATTERY

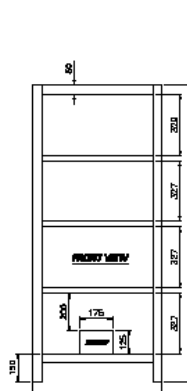
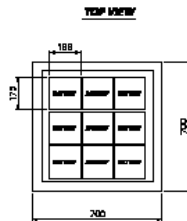

NOTE:- 166 X 175 X 125
4 SHELF - 36 PCS BATTERY
3 SHELF - 27 PCS BATTERY

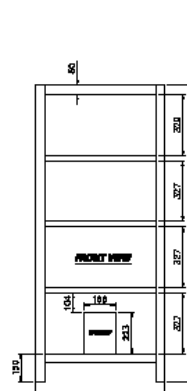
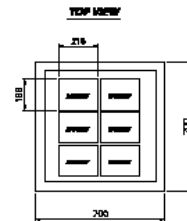

NOTE:- 261 X 168 X 223
4 SHELF - 24 PCS BATTERY
3 SHELF - 18 PCS BATTERY

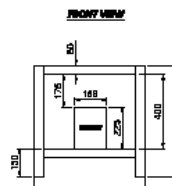
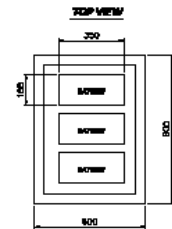

NOTE:- 350 X 168 X 225
1 SHELF - 3 PCS BATTERY



GAMMA BATTERY RACKS



BATTERY RACKS

GAMMA BATTERY RACK

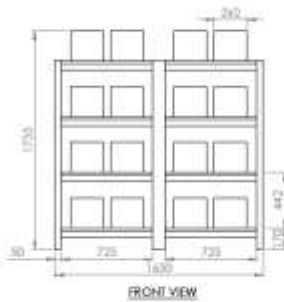

FRONT VIEW

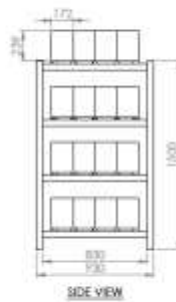

SIDE VIEW



TOP VIEW

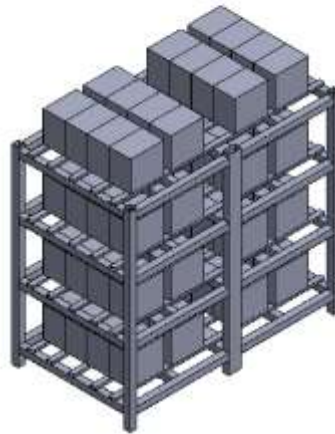

TITLE - BATTERY RACK ASSEMBLY

DRAWN - EHAH

CHECKED - BHG JAHAL

DATE - 08/10/2017

SCALE - 1:1

LOCATION - RYADH - S.A.

GAMMA FOR METAL INDUSTRIES

P.O. BOX 30306, RIYADH 11348,

S.A. TEL: +966 1 448024 / 448027

FAX: +966 1 448028

EHAH - info@gamma.com.sa



CERTIFICATE

01/01/2020

To whom it may concern

We hereby confirm that Gamma Factory for Metal Industries (Saudi Arabia – Riyadh), Are using our SAK COAT Epoxy powder since long time and we do regular inspection for Gamma Electrostatic Powder line and inspect Painted Parts in our lab during the year

We confirm that GAMMA Factory are working as per standard Powder Coating Quality and achieving the recommended Powder supplier work procedure and all there paint parts are matching Powder Quality requirements for both Indoor and Outdoor use.

For SAK Factory for Powder Paint

Mr. Muhammad Khalifa





CERTIFICATE OF REGISTRATION

INTERCERT hereby certifies that the Quality Management System of

GAMMA FACTORY FOR METAL INDUSTRIES

P.O. BOX, 390395 RIYADH 11365 KINGDOM OF SAUDI ARABIA CR# 1010278376

Has been successfully assessed as per the requirements of

ISO 9001:2015

For the scope of

Fabrication of 19 "Networking Rack Panels, Free Standing Cabinets, Open Racks, Wall Mounted Cabinets, Fiber Patch panel, 19" PDU, Battery Enclosures, Outdoor Metal Enclosures, and Soundproof Canopies

Initial Certification Date : 06-07-2020
Certificate Issue Date : 06-07-2020
Surveillance Validity Date : 05-07-2021
Recertification Date : 05-07-2023

Registration Number: IC-QM-2007022

Issued on behalf of InterCert
Head - Certifications





CERTIFICATE OF REGISTRATION

INTERCERT hereby certifies that the Environmental Management System of

GAMMA FACTORY FOR METAL INDUSTRIES

P.O. BOX, 390395 RIYADH 11365 KINGDOM OF SAUDI ARABIA CR# 1010278376

Has been successfully assessed as per the requirements of

ISO 14001:2015

For the scope of

Fabrication of 19" Networking Rack Panels, Free Standing Cabinets, Open Racks, Wall Mounted Cabinets, Fiber Patch panel, 19" PDU, Battery Enclosures, Outdoor Metal Enclosures, and Soundproof Canopies"

Initial Certification Date	:	15-07-2020
Certificate Issue Date	:	15-07-2020
Surveillance Validity Date	:	14-07-2021
Recertification Date	:	14-07-2023

Registration Number: IC-EM-2007064

Issued on behalf of InterCerti
Head - Certifications





GAMMA Short list of Projects

PROJECT	END USER	Consultant
STC - EASTERN PROVINCE EMARAH - INTERNET & SOLUTIONS 500MB	STC - EASTERN EMARAH	
STC WI FI 3G Offloading Project -KASC Jeddah	STC	
Ministry of Health -MOH WEST – MOH ESTERN	Ministry of Health -MOH	
200 BED HOSPITAL – TABUK	Ministry of Health -MOH	
Qasem Hospital	Ministry of Health -MOH	
MOH - PHC	Ministry of Health -MOH	
Riyadh Metro	RMTC	
General Commission for Survey – Phase 2 & 3	GCS	
General Directorate for Health Affairs	Ministry of Health -MOH	
South Boarder Housing	Ministry of Interior -MOI	ARCHEN
King Abdullah Security Project - KAP1	Ministry of Interior -MOI	KHATEEB & ALAMI
King Abdullah Security Project - KAP2	Ministry of Interior -MOI	PROGER Consultant
King Abdullah Security Project - KAP4	Ministry of Interior -MOI	PROGER Consultant
AL SALAM PALACE	JEDDAH	Saudi Diyar Consultants
MIFON Project Phase 3	Ministry of Interior -MOI	
MOI CCTV Project	Ministry of Interior -MOI	
E – learning Project – Tatweer -School Project	Ministry of Education - MOE	
Saudi Electronic University	Ministry of Education - MOE	
King Abdulla Finance District - KAFD	Ministry of Finance -MOF	DAR ALRIYADH Consultant
Royal Saudi Navy Force – RSNF	Ministry of Defense – MOD	
Royal Saudi Air Force – RSAF	Ministry of Defense – MOD	
Strategic Missile Force -SMF	Ministry of Defense – MOD	
SAIC – RSAF PROJECT – USA	SAIC – USA	
King Abdul Aziz Center National Dialogue	General Authority of Civil Aviation	GACA
National Center for Technology Electrical Energy Systems	King Abdulaziz city– KASCT	
Jeddah Islamic Port	Saudi Ports Authority	Marwan Ashour
Thuwal Development Project - Phase I	ARAMCO	
Technical and Vocational Training Corporation	TVTC	
Ministry of Municipal and Rural Affairs	MOMRA	ADD Engineering
Building of Secretary General of the GCC	Gulf Cooperation Council - GCC	Specialist for Geometric
King Abdullah bin Abdulaziz University Hospital	KAAUH	
World Trade Center -WTC	King Abdulla Finance District - MOF	
Samsung C&T	Rabigh-2 Project	
ISLAMIC University	Madinah University – MOE	
AL ULA University	Taiba University – MOE	
Imam Moh’d I University	Imam Moh’d University- MOE	
Prince Satam University	Prince Satam University – MOE	
Al- Jouf University	Al- Jouf University – MOE	
Taima & Hakel University	Tabuk Univesity – MOE	
Hakel University	Tabuk University - MOE	
Radisson Blue Hotel	Al Khobar	EHAF Consultant
Rotana Hotel	Riyadh	
Plazza in Hotel	Riyadh	
Half Moon Beach Hotel	Al-Khobar	
Hyat Regency Hotel	Riyadh	
Hilton Garden In Hotel	Tabuk	
Park Inn hotel	Jeddah	
Narsis Budel Hotel	Riyadh	
Makan Hotel	Al Ahsa	
Nobo Hotel	Riyadh	
Marriott Executive Apartment	Riyadh	KHATEEB & ALAMI

GAMMA CABINETS INSTALLED IN THE BELOW END USERS
THROUGH OUR VALUED CUSTOMER

SOME OF CONSULTANTS AND MINISTRIES REFERENCE LIST

